

Instruction Manual



RTPA2A
Real-Time Spectrum Analyzer
TekConnect[®] Probe Adapter

071-1766-01

Copyright © Tektronix, Inc. All rights reserved. Licensed software products are owned by Tektronix or its suppliers and are protected by United States copyright laws and international treaty provisions.

Use, duplication, or disclosure by the Government is subject to restrictions as set forth in subparagraph (c)(1)(ii) of the Rights in Technical Data and Computer Software clause at DFARS 252.227-7013, or subparagraphs (c)(1) and (2) of the Commercial Computer Software - Restricted Rights clause at FAR 52.227-19, as applicable.

Tektronix products are covered by U.S. and foreign patents, issued and pending. Information in this publication supercedes that in all previously published material. Specifications and price change privileges reserved.

TEKTRONIX, TEK, TekConnect, and TeKProbe are registered trademarks of Tektronix, Inc.

Contacting Tektronix

Tektronix, Inc.
14200 SW Karl Braun Drive or P.O. Box 500
Beaverton, OR 97077 USA

For product information, sales, service, and technical support:

- In North America, call 1-800-833-9200.
- Worldwide, visit www.tektronix.com to find contacts in your area.

Warranty 2

Tektronix warrants that this product will be free from defects in materials and workmanship for a period of one (1) year from the date of shipment. If any such product proves defective during this warranty period, Tektronix, at its option, either will repair the defective product without charge for parts and labor, or will provide a replacement in exchange for the defective product. Parts, modules and replacement products used by Tektronix for warranty work may be new or reconditioned to like new performance. All replaced parts, modules and products become the property of Tektronix.

In order to obtain service under this warranty, Customer must notify Tektronix of the defect before the expiration of the warranty period and make suitable arrangements for the performance of service. Customer shall be responsible for packaging and shipping the defective product to the service center designated by Tektronix, with shipping charges prepaid. Tektronix shall pay for the return of the product to Customer if the shipment is to a location within the country in which the Tektronix service center is located. Customer shall be responsible for paying all shipping charges, duties, taxes, and any other charges for products returned to any other locations.

This warranty shall not apply to any defect, failure or damage caused by improper use or improper or inadequate maintenance and care. Tektronix shall not be obligated to furnish service under this warranty a) to repair damage resulting from attempts by personnel other than Tektronix representatives to install, repair or service the product; b) to repair damage resulting from improper use or connection to incompatible equipment; c) to repair any damage or malfunction caused by the use of non-Tektronix supplies; or d) to service a product that has been modified or integrated with other products when the effect of such modification or integration increases the time or difficulty of servicing the product.

THIS WARRANTY IS GIVEN BY TEKTRONIX WITH RESPECT TO THE PRODUCT IN LIEU OF ANY OTHER WARRANTIES, EXPRESS OR IMPLIED. TEKTRONIX AND ITS VENDORS DISCLAIM ANY IMPLIED WARRANTIES OF MERCHANTABILITY OR FITNESS FOR A PARTICULAR PURPOSE. TEKTRONIX' RESPONSIBILITY TO REPAIR OR REPLACE DEFECTIVE PRODUCTS IS THE SOLE AND EXCLUSIVE REMEDY PROVIDED TO THE CUSTOMER FOR BREACH OF THIS WARRANTY. TEKTRONIX AND ITS VENDORS WILL NOT BE LIABLE FOR ANY INDIRECT, SPECIAL, INCIDENTAL, OR CONSEQUENTIAL DAMAGES IRRESPECTIVE OF WHETHER TEKTRONIX OR THE VENDOR HAS ADVANCE NOTICE OF THE POSSIBILITY OF SUCH DAMAGES.

Table of Contents

General Safety Summary	iii
Environmental Considerations	v
Getting Started	1
Cable Connections	1
USB Cable	1
Real-Time Spectrum Analyzer Software Compatibility	2
TekConnect Probe Compatibility	2
Standard Accessories	3
Options	5
Installing the Probe Adapter	7
CONNECTIONS Table	8
Installing the USB Cable and Power Supply Cable	9
Installing the TekConnect Probe	10
Performing a Functional Check	11
Operating Basics	17
Understanding the Controls	17
Power Status	17
USB Status	18
Probe Status	18
Reference	19
Avoiding Damage from Electrostatic Discharge or Overvoltage	19
Specifications	21
Certifications and Compliances	24
Maintenance	25
Inspecting and Cleaning	25
Troubleshooting	26
Product Requires Service	27
Repackaging for Shipment	27
Replaceable Parts	29
Parts Ordering Information	29
Using the Replaceable Parts List	30

List of Figures

Figure 1: The TekConnect probe adapter	1
Figure 2: Probe adapter inputs and outputs	7
Figure 3: Back panel connections	9
Figure 4: Installing TekConnect probes	10
Figure 5: Connecting the RTPA2A components	12
Figure 6: Check for lighted LEDs	13
Figure 7: Equipment setup with Real-Time Spectrum Analyzer ...	14
Figure 8: Amplitude signal	15
Figure 9: Location of status LEDs	17
Figure 10: Insertion loss	23
Figure 11: Return loss	23
Figure 12: Exploded view	34

List of Tables

Table 1: Compatible probes	2
Table 2: Standard accessories	3
Table 3: Options	5
Table 4: Power cord options	5
Table 5: Recommended equipment for functional check	11
Table 6: Probe amplitude offset for Channel B	15
Table 7: Power status LED	17
Table 8: USB status LED	18
Table 9: Probe status LED	18
Table 10: Electrical characteristics	21
Table 11: Environmental characteristics	22
Table 12: Physical characteristics	22
Table 13: Probe adapter LEDs	26

General Safety Summary

Review the following safety precautions to avoid injury and prevent damage to this product or any products connected to it.

To avoid potential hazards, use this product only as specified.

Only qualified personnel should perform service procedures.

While using this product, you may need to access other parts of the system. Read the *General Safety Summary* in other system manuals for warnings and cautions related to operating the system.

To Avoid Fire or Personal Injury

Connect and Disconnect Properly. Do not connect or disconnect probes or test leads while they are connected to a voltage source.

Connect the probe output to the measurement instrument before connecting the probe to the circuit under test. Disconnect the probe input and the probe ground from the circuit under test before disconnecting the probe from the measurement instrument.

Ground the Product. This product is grounded through the grounding conductor of the power cord. To avoid electric shock, the grounding conductor must be connected to earth ground. Before making connections to the input or output terminals of the product, ensure that the product is properly grounded.

Observe All Terminal Ratings. To avoid fire or shock hazard, observe all ratings and markings on the product. Consult the product manual for further ratings information before making connections to the product.

The common terminal is at ground potential. Do not connect the common terminal to elevated voltages.

Connect the ground lead of the probe to earth ground only.

Do not apply a potential to any terminal, including the common terminal, that exceeds the maximum rating of that terminal.

Power Disconnect. The power cord disconnects the product from the power source. Do not block the power cord; it must remain accessible to the user at all times.

Do Not Operate Without Covers. Do not operate this product with covers or panels removed.

Avoid Exposed Circuitry. Do not touch exposed connections and components when power is present.

Do Not Operate With Suspected Failures. If you suspect there is damage to this product, have it inspected by qualified service personnel.

Provide Proper Ventilation. Refer to the manual's installation instructions for details on installing the product so it has proper ventilation.

Use Proper AC Adapter. Use only the AC adapter specified for this product.

Do Not Operate in Wet/Damp Conditions.

Do Not Operate in an Explosive Atmosphere.

Keep Product Surfaces Clean and Dry.

Symbols and Terms

Terms in this Manual. These terms may appear in this manual:



WARNING. *Warning statements identify conditions or practices that could result in injury or loss of life.*



CAUTION. *Caution statements identify conditions or practices that could result in damage to this product or other property.*

Terms on the Product. These terms may appear on the product:

DANGER indicates an injury hazard immediately accessible as you read the marking.

WARNING indicates an injury hazard not immediately accessible as you read the marking.

CAUTION indicates a hazard to property including the product.

Symbols on the Product. The following symbols may appear on the product:



Environmental Considerations

This section provides information about the environmental impact of the product.

Product End-of-Life Handling

Observe the following guidelines when recycling an instrument or component:

Equipment Recycling. Production of this equipment required the extraction and use of natural resources. The equipment may contain substances that could be harmful to the environment or human health if improperly handled at the product's end of life. In order to avoid release of such substances into the environment and to reduce the use of natural resources, we encourage you to recycle this product in an appropriate system that will ensure that most of the materials are reused or recycled appropriately.



The symbol shown to the left indicates that this product complies with the European Union's requirements according to Directive 2002/96/EC on waste electrical and electronic equipment (WEEE). For information about recycling options, check the Support/Service section of the Tektronix Web site (www.tektronix.com).

Restriction of Hazardous Substances

This product has been classified as Monitoring and Control equipment, and is outside the scope of the 2002/95/EC RoHS Directive. This product is known to contain lead, cadmium, mercury, and hexavalent chromium.

Getting Started

The TekConnect probe adapter allows you to connect a TekConnect probe to a Real-Time Spectrum Analyzer. The TekConnect probe adapter is comprised of an enclosure that houses two probe inputs. The probe adapter connects to a Real-Time Spectrum Analyzer through a USB cable and a coaxial cable.

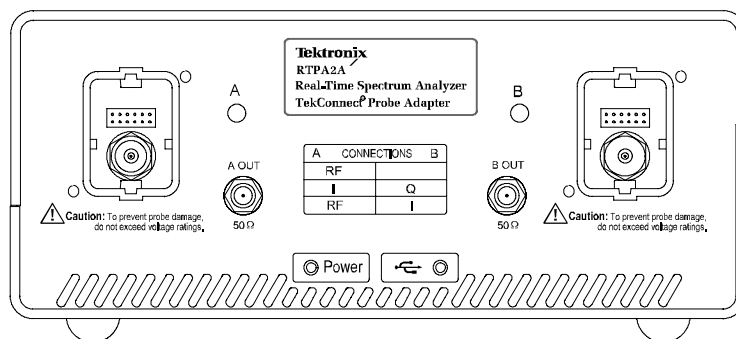

Figure 1: The TekConnect probe adapter

Cable Connections

Power The power for the probe adapter and probe is supplied through the DC power supply cable.

USB Cable The USB cable provides a data and communications path from the probe adapter to the Real-Time Spectrum Analyzer. Probe characteristic data transfers through this cable.

Real-Time Spectrum Analyzer Software Compatibility

If your product is running Windows 98 application software, you need to upgrade to Windows XP to use the TekConnect probe adapter. To upgrade your product, contact the Tektronix support center (for contact information, see the contact page at the front of this manual).

If your product is a RSA2200A, RSA3300A, RSA3408A, or WCA200A Series instrument, it requires Main System software shipped after August 2005 to be compatible with the TekConnect probe adapter. Contact Tektronix technical support if you need to verify that your Main System software supports the RTPA2A TekConnect probe adapter.

For questions about an instrument not listed here, contact the Tektronix support center.

TekConnect Probe Compatibility

The TekConnect probe adapter supports only TekConnect probes. Refer to Table 1 for a list of compatible probes.

Table 1: Compatible probes

Probe	Attenuation	Description
P7225	10x	Active Probe
P7240	5x	Active Probe
P7260	5x, 25x	Active Probe
P7330	5x	Differential Probe
P7313	5x, 25x	Differential Probe
P7350	6.25x	Differential Probe
P7350SMA	6.25x	Differential Probe
P7380	5x, 25x	Differential Probe
P7380SMA	2.5x 12.5x	Differential Probe

There is no support for TekProbe Level 2 legacy probes that use the TCA-1MEG, TCA-BNC, and TCA75 adapters.

Standard Accessories

Table 2 lists the standard accessories. Order extra standard accessories as needed.

Table 2: Standard accessories



Accessory	Description ¹
	<p>50 Ω SMA-to-N Cable. Use the 50 Ω SMA-to-N Cable to connect the TekConnect probe adapter to the Real-Time Spectrum Analyzer. The SMA cable passes the analog signal output from the probe adapter channel to the spectrum analyzer.</p>
	<p>BNC-to-N adapter. Use the BNC-to-N adapter to connect the TekConnect probe adapter to the Real-Time Spectrum Analyzer RF input.</p>
	<p>USB Cable. Provides a data and communications path from a TekConnect probe adapter to the Real-Time Spectrum Analyzer.</p>
	<p>Power Cord. Provides AC power to the power supply. Option A0 comes standard with the TekConnect probe adapter. See page 5 for power cord options.</p>

Table 2: Standard accessories (Cont.)

Accessory	Description ¹
	<p>Power Supply and cable. Provides DC power to the TekConnect probe adapter.</p>
	<p>Statement of compliance. A certificate verifying that the product is assembled and verified using established procedures and work instructions. When applicable, test equipment is traceable to known standards.</p> <p>Included with product at initial shipment. This accessory cannot be ordered.</p>
	<p>Instruction Manual. Provides instruction and information about the TekConnect probe adapter.</p> <p>Quick Reference Card. Provides RF, I, and Q setups for the TekConnect probe adapter and the Real-Time Spectrum Analyzer.</p>

¹ See page 32 for Tektronix part numbers.

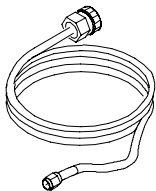
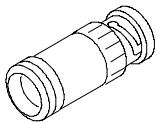
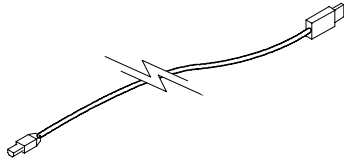
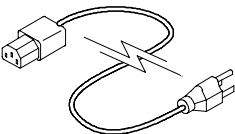
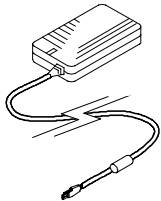
Options

Table 3 and 4 lists options that are available for the TekConnect probe adapter.

Table 3: Options

Option	Description
R3	Repair Service 3 years (available at purchase only)
R5	Repair Service 5 years (available at purchase only)
L0	English Instruction Manual ¹
L5	Japanese Instruction Manual ¹

¹ See page 32 for Tektronix part numbers.

Table 4: Power cord options

Plug configuration	Normal usage	Option number ¹
	North America 120 V	A0 (Standard) 161-0066-00
	Universal Euro	A1 161-0066-09
	United Kingdom	A2 161-0066-10
	Australia	A3 161-0066-13
	North America 250 V	A4 161-0104-08

Table 4: Power cord options (Cont.)

Plug configuration	Normal usage	Option number ¹
	Switzerland	A5 161-0154-00
	Japan	A6 161-A005-00
	China	A10 161-0306-00
	No power cord supplied.	A99

¹ See page 33 for Tektronix part numbers.

Installing the Probe Adapter

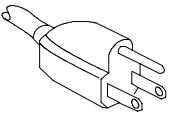
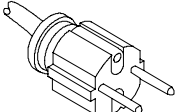
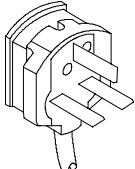
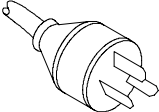
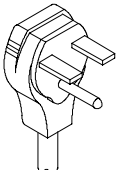
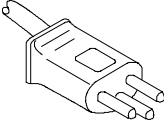
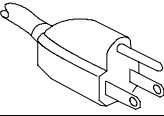
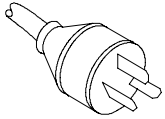
Figure 2 shows the TekConnect probe adapter, standard accessories, and location of the probe inputs.

You must allow for airflow clearance for the probe adapter; see page 22 for the required clearance.

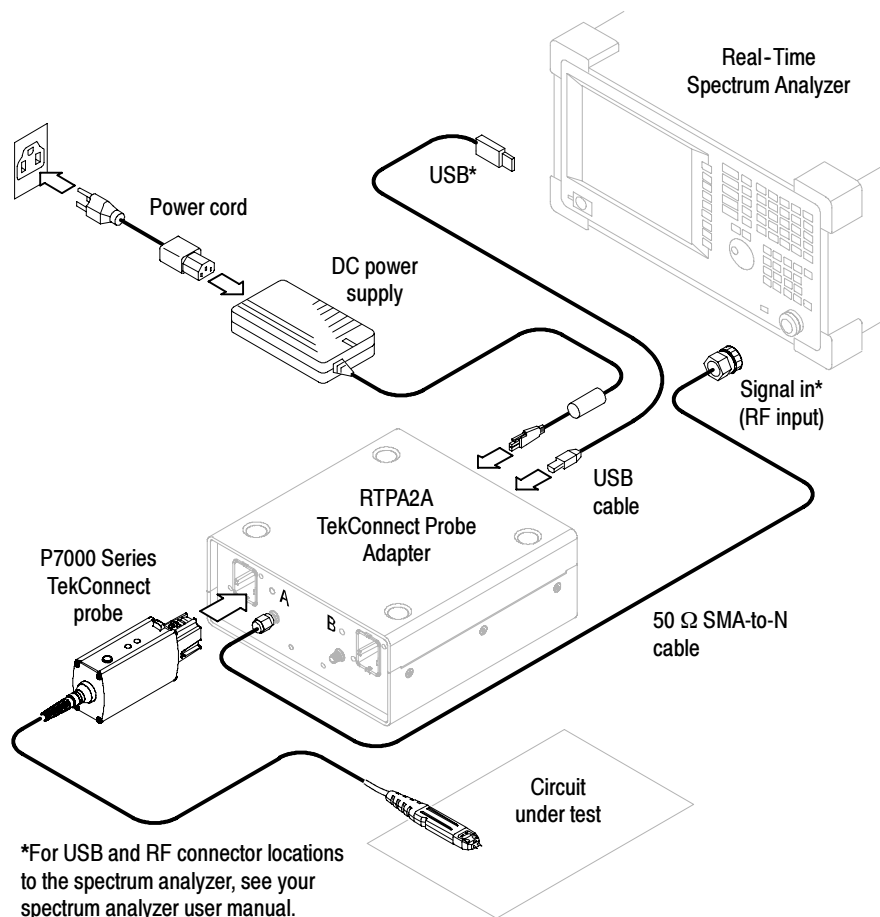

Figure 2: Probe adapter inputs and outputs

Installing the probe adapter consists of the following steps:

1. Install the power cord.
2. Install the power supply cable.
3. Install the USB cable (also to the spectrum analyzer).

4. Install a 50 Ω SMA-to-N cable (also to the spectrum analyzer RF input). Torque to 8 in-lb.



CAUTION. *To prevent damage to the probe or spectrum analyzer, do not exceed the voltage ratings specified on your TekConnect probe. For further probe information, refer to your probe instruction manual, and if necessary, the ABC's of Probes on the Tektronix Web site.*

5. Install a P7000 Series TekConnect probe.

CONNECTIONS Table

All procedures in this instruction manual agree with the cable configurations shown in the CONNECTIONS table.

NOTE. *The CONNECTIONS table on the front of the probe adapter recommends cable and probe connections to the spectrum analyzer. For the spectrum analyzer to apply correct probe-related amplitude offsets, you must connect the cables as shown under columns A and B. See the RTPA2A Real-Time Spectrum Analyzer TekConnect Probe Adapter Setups Quick Reference for instructions on setting up these connections.*

Installing the USB Cable and Power Supply Cable

When a USB cable is connected to a Tektronix Real-Time Spectrum Analyzer, power is enabled to the probe. The USB cable must be attached for the probe adapter and a spectrum analyzer system to function properly.

Use only the supplied power supply cable and power cord with the TekConnect probe adapter.

Figure 3 shows the USB and power supply connections on the back of the probe adapter. To locate a USB connection on a Real-Time Spectrum Analyzer, refer to your user manual.

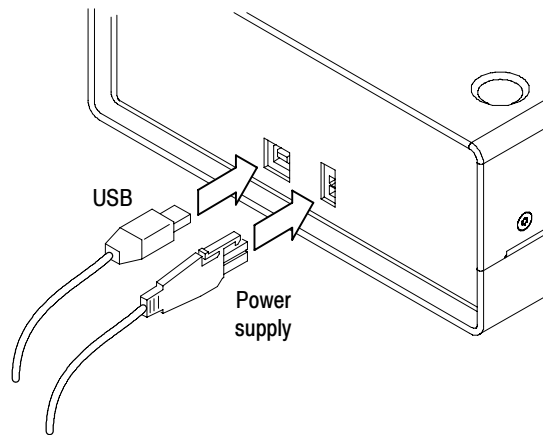

Figure 3: Back panel connections

Installing the TekConnect Probe

When the probe is connected, the probe adapter reads EEPROM information from the probe, identifying the device and allowing the appropriate power supplies to be powered on.

NOTE. *It is not necessary to power off the probe adapter when removing or installing a TekConnect probe.*

The TekConnect interface features a spring-loaded latch that provides audible and tactile confirmation that a reliable connection has been made to the probe adapter. Slide the probe into the TekConnect receptacle on the probe adapter. The probe snaps into the receptacle when fully engaged. See Figure 4.

To release the probe from the probe adapter, grasp the compensation box, press the latch button, and pull out the probe.

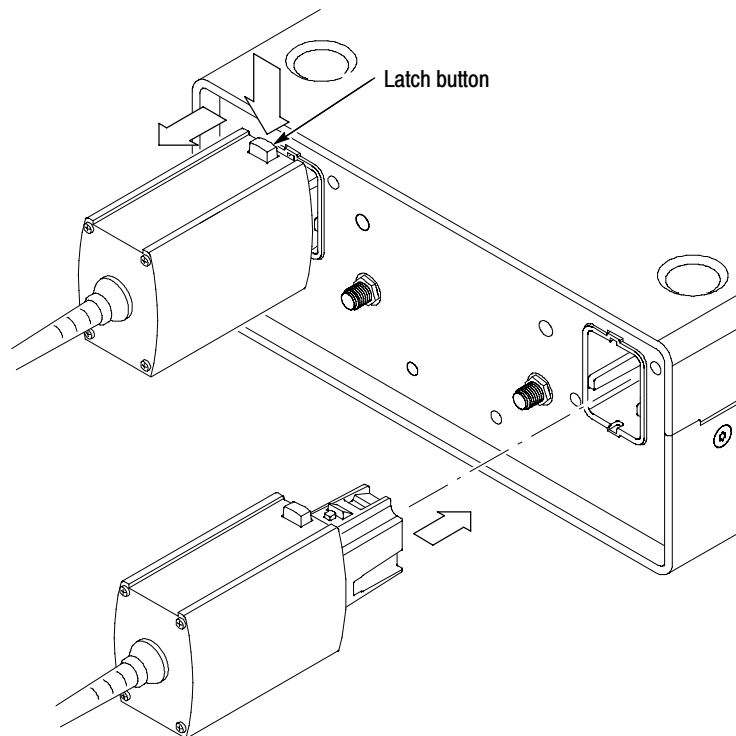

Figure 4: Installing TekConnect probes

Performing a Functional Check

To verify that the TekConnect probe adapter is functioning properly, perform the following procedure. Refer to Table 5 for a list of recommended equipment.

Table 5: Recommended equipment for functional check

Item description	Recommended example
Real-Time Spectrum Analyzer	Tektronix RSA2200A, RSA3300A, RSA3408A, or WCA200A Series (see page 2 for spectrum analyzer software compatibility)
USB cable ¹	174-4401-xx ²
Power supply and cable ¹	119-7017-xx ²
50 Ω SMA-to-N cable ¹	174-5218-xx ²
TekConnect probe	Tektronix P7000 Series
Probe tip adapter	Attaching the probe tip will leave your hands free to perform the functional check. Use the standard accessories recommended in the functional check for your TekConnect probe to attach the probe tip to a connector.
50 Ω (M-to-M) RF coaxial cable	012-0057-xx ²
BNC (F-to-F) adapter	103-0028-xx ²
T-BNC (M-to-two F) connector	103-0030-xx ² or equivalent
50 Ω (BNC-type) termination	011-0049-xx ² or equivalent

¹ **Included with the RTPA2A TekConnect probe adapter.**

² **Nine-digit part numbers (xxx-xxxx-xx) are Tektronix part numbers.**

To verify the functionality of Channel A, perform the following tasks:

1. Set up the spectrum analyzer:
 - a. Power on and wait for the boot-up process to complete, if necessary.
 - b. Preset the factory defaults. For example, RSA2203A - Press the System key, and then press the Reset All to Factory Defaults side key.
 - c. Set the center frequency to 10 MHz.
 - d. Set the span to 1 MHz.

2. Connect the probe adapter as shown in Figure 5. If necessary, refer to *Installing the Probe Adapter* on page 7 for more information.

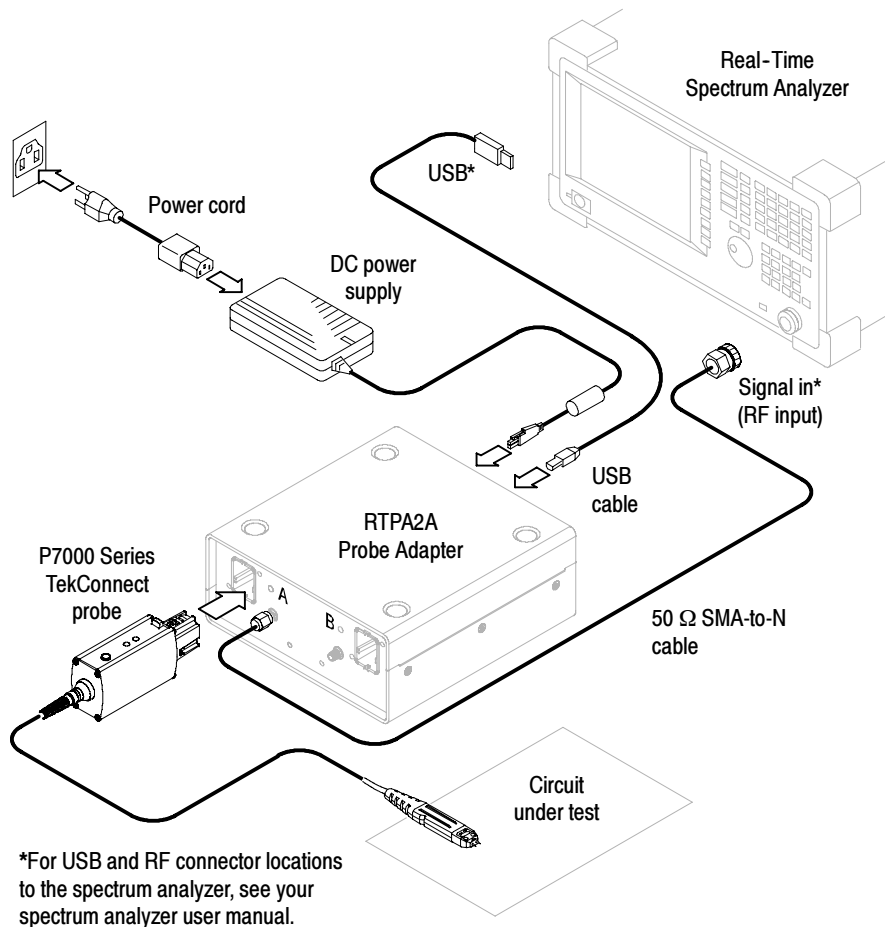

Figure 5: Connecting the RTPA2A components

3. On the probe adapter, visually check that the LEDs are lighted green. The status LEDs on the probe adapter are lighted only when a probe is attached. The LED locations are shown in Figure 6.

If they are not lighted green, see the *Troubleshooting* section on page 26.

NOTE. The probe adapter automatically powers off, if the fan fails.

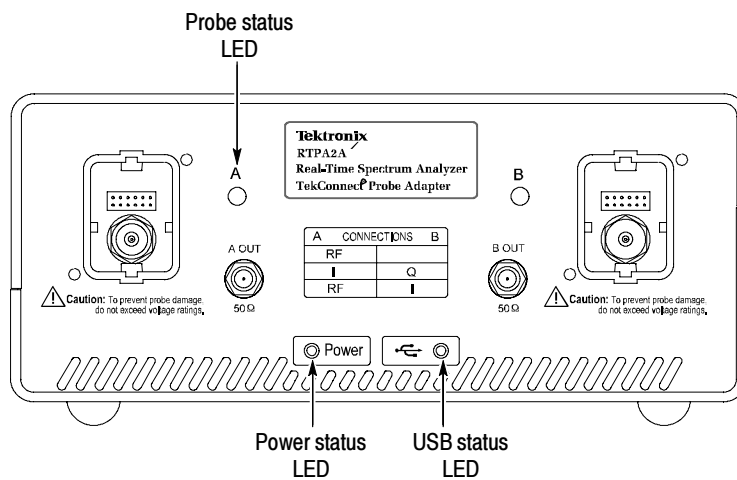

Figure 6: Check for lighted LEDs

4. Connect the spectrum analyzer:
 - a. Attach one end of a 50 Ω cable to the REF OUT connector on the spectrum analyzer.
 - b. Attach the other end of a 50 Ω cable to a BNC (F-to-F) barrel connector. See Figure 7.
 - c. Attach the BNC (F-to-F) barrel connector to the center T-BNC connector.
 - d. Attach the 50 Ω (BNC type) termination to an open end of the T-BNC connector.

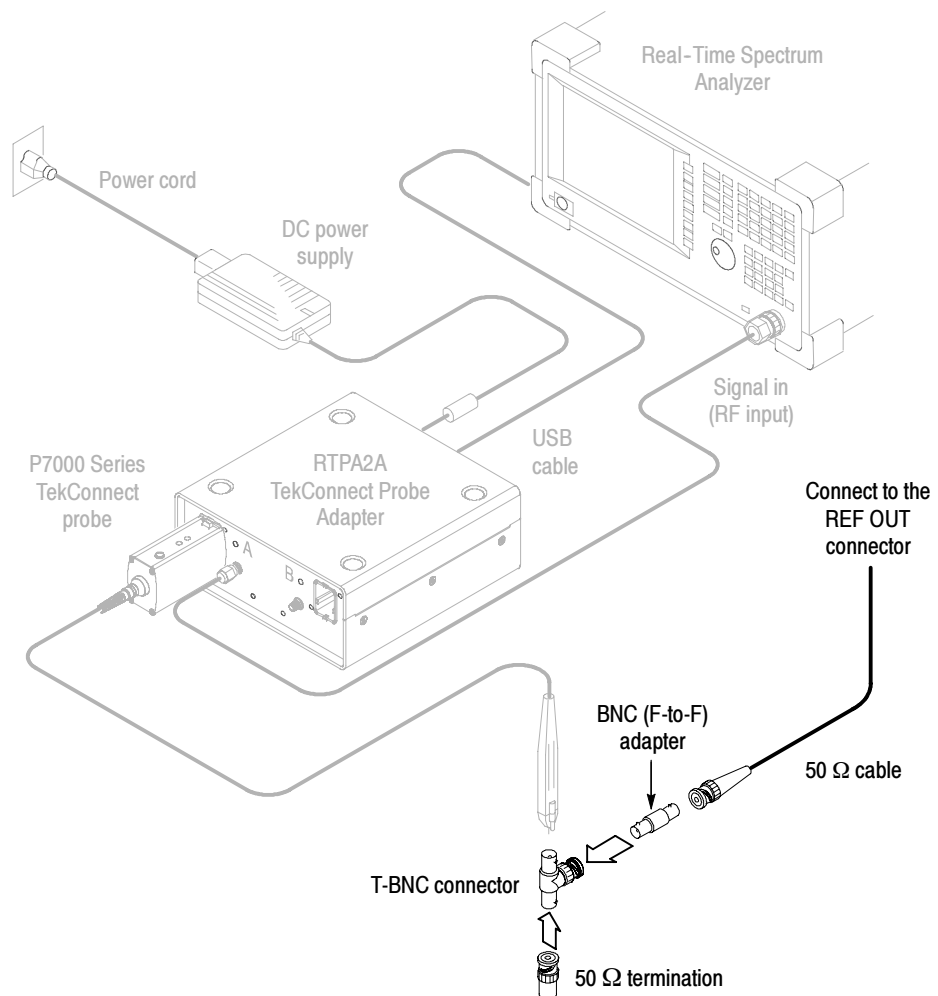

Figure 7: Equipment setup with Real-Time Spectrum Analyzer

5. Install a probe-tip adapter on the probe (optional). This leaves your hands free to complete the rest of the functional check. See Table 5 on page 11 for probe-tip adapter information.
6. Connect the probe tip to the open end of the T-BNC connector.

The spectrum analyzer displays an amplitude signal ($0 \text{ dBm} \pm 5 \text{ dB}$) as shown in Figure 8.

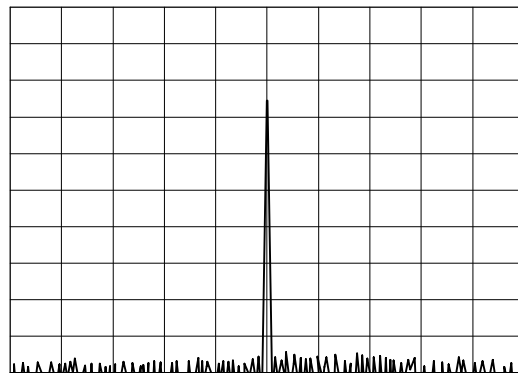

Figure 8: Amplitude signal

To verify the functionality of Channel B, perform the following tasks:

1. Move the probe from Channel A to Channel B.
2. Move the SMA cable from A OUT to B OUT.

NOTE. The spectrum analyzer will adjust the RF amplitude offset for Channel A only. To correct the amplitude for Channel B, see Table 6. For example, if you are using a 5X probe on Channel B, manually apply an amplitude offset of -14 dB.

Table 6: Probe amplitude offset for Channel B

Probe Attenuation	≈ Amplitude Offset
2.5X	-8 dB
5X	-14 dB
6.25X	-16 dB
10X	-20 dB
12.5X	-22 dB
25X	-28 dB

Operating Basics

This section contains information you need to operate the TekConnect probe adapter.

Understanding the Controls

The front panel on the TekConnect probe adapter has an LED for the status of power, USB, and each probe connection. See the following LED status explanations.

See page 26 for troubleshooting information.

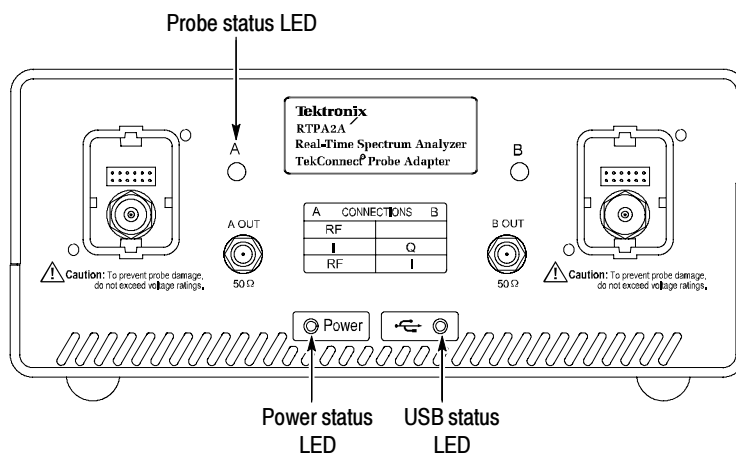

Figure 9: Location of status LEDs

Power Status Table 7 describes LED operation when power is on.

Table 7: Power status LED

LED	Indicates
Solid green	Proper power is applied
Off	The probe adapter is not receiving power

USB Status Table 8 describes LED operation when a USB cable is attached.

Table 8: USB status LED

LED	Indicates
Solid green	The USB host is detected and the spectrum analyzer is supported
Flashes green	The USB host is detected, but the spectrum analyzer is not supported
Off	The USB host was not detected; recheck the USB cable

Probe Status Table 9 describes LED operation when a TekConnect probe is attached.

Table 9: Probe status LED

LED	Indicates
Solid green	A supported probe is attached
Solid red	An unsupported or unrecognized probe is attached.
Off	No power to the probe adapter
	TekConnect receptacle did not detect a probe

NOTE. *The Power and USB LEDs must both be solid green for the probe status LEDs to operate.*

Reference

This section contains information you may need to take measurements or to avoid damaging the RTPA2A product.

Avoiding Damage from Electrostatic Discharge or Overvoltage

Circuitry in the TekConnect probe adapter and probe is very susceptible to damage from electrostatic discharge or from overdrive signals. Be sure to operate the system only in a static-controlled environment. Be sure to discharge to ground any electrostatic charge that may be present on the center and outer connectors of cables before attaching the cables to the system. Be sure to operate the TekConnect probe adapter and probe only where DC voltage levels are within the probe limits. Refer to the probe specifications in your probe instruction manual.

Specifications

This section lists the electrical, environmental, and physical characteristics of the RTPA2A product.

Typical specifications are provided for your convenience and are not guaranteed.

The electrical characteristics listed in Table 10 are valid when the RTPA2A product operates within the environmental conditions listed in Table 11 on page 22.

Table 10: Electrical characteristics

Characteristic	Description
Output Impedance, nominal	50 Ω ¹
Frequency range ² , typical	DC to > 8 GHz
Insertion loss, typical	
Without RF cable attached	DC to 4 GHz: < 0.3 dB (see Figure 10 on page 23) DC to 8 GHz: < 0.8 dB
With 1 meter (M-to-M) cable	DC to 4 GHz: < 0.7 dB DC to 8 GHz: < 1.0 dB
Return Loss, typical	
Without RF cable attached	DC to 4 GHz: > 20 dB (see Figure 11 on page 23) DC to 8 GHz: > 18 dB
With 1 meter (M-to-M) cable	DC to 4 GHz: > 20 dB DC to 8 GHz: > 18 dB
Electrical Delay, nominal	
Without RF cable attached	470 ps
With 1 meter male to male cable	4.62 ns

¹ **Provided by the spectrum analyzer input.**

² **Provided by the RTPA2A product only.**

Table 11: Environmental characteristics

Characteristic	Description
Temperature Range	
Operating	10 °C to 40 °C (50 °F to 104 °F)
Nonoperating	-20 °C to +60 °C (-68 °F to 140 °F)
Humidity	
Operating	20 to 80% RH, noncondensing
Nonoperating	5 to 90% RH, noncondensing
Altitude	
Operating	3,048 m (10,000 ft)
Nonoperating	12,190 m (40,000 ft)
Mechanical Shock	50 g half-sine: 11 ms
Required airflow clearance (front and back)	2 in (5.08 cm)

Table 12: Physical characteristics

Characteristic	Description
Weight ¹	1.07 kg (2.36 lbs)
Dimensions	Height: 110 mm (4.250 in) Width: 70 mm (2.750 in) Depth: 42 mm (1.625 in)
Cable Length, nominal	1 m (3.28 ft)

¹ **Does not include accessories and shipping container.**

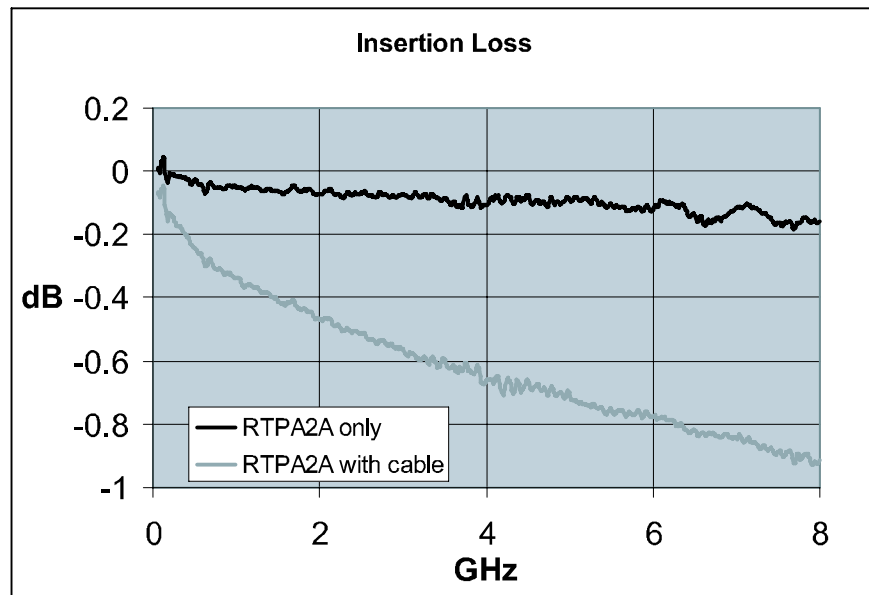

Figure 10: Insertion loss

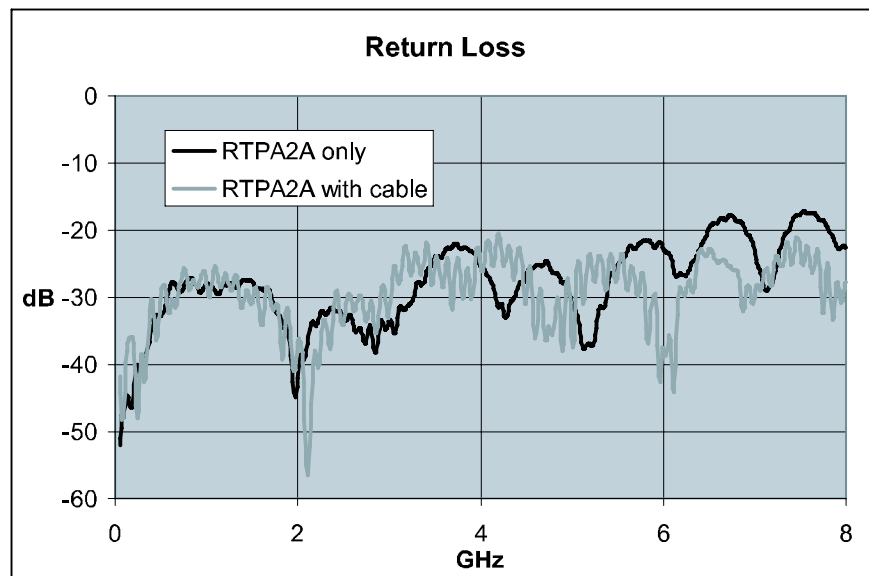

Figure 11: Return loss

Certifications and Compliances

EC Declaration of Conformity - EMC

Meets intent of Directive 89/336/EEC for Electromagnetic Compatibility. Compliance was demonstrated to the following specifications as listed in the Official Journal of the European Communities:

EN 61326. EMC requirements for Class A electrical equipment for measurement, control, and laboratory use. Annex D.^{1, 2}

- IEC 61000-4-2. Electrostatic discharge immunity
- IEC 61000-4-3. RF electromagnetic field immunity
- IEC 61000-4-4. Electrical fast transient / burst immunity
- IEC 61000-4-5. Power line surge immunity
- IEC 61000-4-6. Conducted RF immunity
- IEC 61000-4-11. Voltage dips and interruptions immunity

EN 61000-3-2. AC power line harmonic emissions

EN 61000-3-3. Voltage changes, fluctuations, and flicker

Australia / New Zealand Declaration of Conformity - EMC

Complies with EMC provision of Radio communications Act per these standard(s):

- AS/NZS 2064.1/2. Industrial, Scientific, and Medical Equipment: 1992

¹ Emissions which exceed the levels required by this standard may occur when this equipment is connected to a test object.

² Use Low-EMI Shielded cables to maintain compliance.

Maintenance

This section contains information on troubleshooting and how to clean and maintain your equipment.

Inspecting and Cleaning

Remove accumulated loose dust from the probe adapter with a soft cloth or brush. Remaining dirt may be removed with a soft cloth dampened with isopropyl alcohol.

Do not immerse any equipment in cleaning solutions or use abrasive cleaners.



CAUTION. *To prevent damage, avoid using cleaning materials that contain acetone, benzene, toluene, xylene, or similar solvents.*

Troubleshooting

If you encounter problems installing or operating the probe adapter, try the troubleshooting procedures in Table 13 before returning the probe adapter for service.

NOTE. *If problems occur with your TekConnect probe adapter, the Technical Support Center may need the firmware version of your probe adapter to isolate the symptoms to a specific cause. The firmware version number is located on the back of the TekConnect probe adapter.*

Table 13: Probe Adapter LEDs

LEDs			Problem	Check
Power	USB	Probe		
on	on	green	none (probe adapter performing correctly)	—
off	off	off	Power status LED remains off	Power cord connection.
on	off	off	USB status LED remains off	USB connections on the probe adapter and spectrum analyzer.
on	flashing	off	USB status LED flashes	If the spectrum analyzer software needs to be upgraded. Refer to <i>Real-Time Spectrum Analyzer Software Compatibility</i> on page 2, for more information.
on	on	off	Probe status LED on the probe adapter remains off, and the fan is not rotating	An internal fault has been detected. Send the probe adapter for service.
			Probe status LED on the probe adapter remains off, and the fan is rotating	If the probe status LED lights when the probe is connected to the other probe adapter channel, send the probe adapter for service. If the probe function incorrectly in a TekConnect scope, send the probe for service. If the probe status LED on the probe adapter does not light in either channel but the probe functions in a TekConnect scope, send the probe adapter for service.
on	on	red	Probe status LED is Red	Table 1 on page 2 for probe compatibility.
on	on	green	No Signal Detected (from the connected TekConnect probe)	The 50 Ω cable connection(s) between the spectrum analyzer and the probe adapter.

Product Requires Service

The following conditions indicate an internal failure. See the copyright page at the front of the manual for information on contacting Tektronix for service.

- No probe-adapter LEDs active at power on.
- Probe status LEDs are inactive on one channel, but are active on the other channel of the TekConnect probe adapter.
- Probe status LED response is inconsistent when connecting the same probe alternately to each channel of the TekConnect probe adapter.
- USB status LED flashes even when attached to a valid Real-Time Spectrum Analyzer.
- Neither probe status LED lights when working probes are attached.
- Power status LED is lighted, but the fan is not rotating.

Repackaging for Shipment

If the original packaging is unfit for use or not available, use the following packaging guidelines:

1. Use a corrugated cardboard shipping carton having inside dimensions at least one inch greater than the probe dimensions. The box must have a carton test strength of at least 200 pounds.
2. Place the probe adapter into an antistatic bag or wrap to protect it from dampness.
3. Place the probe adapter into the box and stabilize it with light packing material.
4. Seal the carton with shipping tape.

Replaceable Parts

This section contains a list of the replaceable parts for the RTPA2A TekConnect probe adapter. Use this list to identify and order replacement parts.

Parts Ordering Information

Replacement parts are available through your local Tektronix field office or representative.

Changes to Tektronix products are sometimes made to accommodate improved components as they become available and to give you the benefit of the latest improvements. Therefore, when ordering parts, it is important to include the following information in your order:

- Part number
- Instrument type or model number
- Instrument serial number
- Instrument modification number, if applicable

If you order a part that has been replaced with a different or improved part, your local Tektronix field office or representative will contact you concerning any change in part number.

Using the Replaceable Parts List

This section contains a list of the mechanical and or electrical components that are replaceable. Use this list to identify and order replacement parts. The following table describes each column in the parts list.

Parts list column descriptions

Column	Column name	Description
1	Figure & index number	Items in this section are referenced by figure and index numbers to the exploded view illustrations that follow.
2	Tektronix part number	Use this part number when ordering replacement parts from Tektronix.
3 and 4	Serial number	Column three indicates the serial number at which the part was first effective. Column four indicates the serial number at which the part was discontinued. No entry indicates the part is good for all serial numbers.
5	Qty	This indicates the quantity of parts used.
6	Name & description	An item name is separated from the description by a colon (:). Because of space limitations, an item name may sometimes appear as incomplete. Use the U.S. Federal Catalog handbook H6-1 for further item name identification.
7	Mfr. code	This indicates the code of the actual manufacturer of the part.
8	Mfr. part number	This indicates the actual manufacturer's or vendor's part number.

Abbreviations Abbreviations conform to American National Standard ANSI Y1.1-1972.

Mfr. Code to Manufacturer Cross Index The table titled Manufacturers Cross Index shows codes, names, and addresses of manufacturers or vendors of components listed in the parts list.

Manufacturers cross index

Mfr. code	Manufacturer	Address	City, state, zip code
	SONY	COMPUTER PERIPHERALS COM- PONENTS~EUROPE~HUGO-ECKENER- STRASSE 20	D-50829 KOELN, DE
060D9	TENSOLITE COMPANY	PRECISION HARNESS AND ASSEMBLY~3000 COLUMBIA HOUSE BLVD~#120	VANCOUVER, WA 98661
0J9P9	GEROME MFG CO INC	PO BOX 737~403 NORTH MAIN	NEWBERG, OR 97132
0KB01	STAUFFER SUPPLY CO	810 SE SHERMAN	PORTLAND, OR 97214-4657
0KB05	NORTH STAR NAMEPLATE INC	LABEL PRODUCTS~5750 NE MOORE COURT	HILLSBORO, OR 97124-6474
1BSB6	POTRANS	16591 NOYES AVE	IRVINE, CA 92606
24931	FCI USA INC	RF/COAXIAL DIV~2100 EARLYWOOD DR~PO BOX 547	FRANKLIN, IN 46131
2K262	BOYD CORPORATION	6136 NE 87TH AVENUE	PORTLAND, OR 97220
78189	SHAKEPROOF	DIVISION OF ILLINOIS TOOL WORK~ST. CHARLES ROAD	ELGIN, IL 60120
93907	CAMCAR DIV OF TEXTRON INC	ATTN: ALICIA SANFORD~516 18TH AVE	ROCKFORD, IL 611045181
80009	TEKTRONIX	14200 SW KARL BRAUN DRIVE P.O. BOX 500	BEAVERTON, OR 97077
S3109	FELLER U.S. CORPORATION	10B VAN DYKE AVENUE	NEW BRUNSWICK, NJ 08901
TK1373	PATELEC-CEM	10156 TORINO~VAICENTALLO~62/456	ITALY
TK1943	NEILSEN MANUFACTURING INC	3501 PORTLAND RD NE	SALEM, OR 97303
TK2548	XEROX CORPORATION	7431 EVERGREEN PARKWAY	HILLSBORO, OR 97124
TK2565	VISION PLASTICS INC	26000 SW PARKWAY CENTER DRIVE	WILSONVILLE, OR 97070
TK6121	TUMBLER CORP	4241 BUSINESS CENTER DR	FREMONT, CA 94538
TK6159	ARROW/RICHEY ELECTRONICS	ARROW/RICHEY VALUE ADDED~2900 NW 229TH AVE	HILLSBORO, OR 97124
TK6253	VOLEX INC	646 CARRIBEAN DR	SUNNYVALE, CA 94089-1108
TK6372	VOLEX INC	POWER CORD PRODUCTS~5350 LAKEVIEW PARKWAY~SOUTH DRIVE, SUITE D	INDIANAPOLIS, IN 46268
TK6457	BEIJING MINGDAR TECHNOLOGY INC	RM 213 LUIPU BLDG~NO 5 XIAGUANG- LI~CHAOYANG DISTRICT	BEIJING, CN
TK6625	ENU INC	2038 NW ALOCLEK DRIVE #213	HILLSBORO, OR 97124

Replaceable parts list

Fig. & index number	Tektronix part number	Serial no. effective	Serial no. discont'd	Qty	Name & description	Mfr. code	Mfr. part number
12-1	200-4827-XX			1	COVER; EXTERIOR,AL;SAFETY CONTROLLED	TK1943	200-4827-XX
-2	174-5189-XX			1	CABLE ASSEMBLY;2X8 .100 CENTER, .050 RIBBON, 8.00 LONG	060D9	174-5189-XX
-3	671-6079-XX			1	CIRCUIT BD ASSY;USB;389378500,WIRED	80009	671-6079-XX
-4	211-0722-XX			1	SCREW,MACHINE; 6-32 X 0.250,PNH,STL,CDPL,T-15 TORX DR	0KB01	211-0722-XX
-5	335-1350-XX			1	MARKER,IDENT; LABEL, REAR PANEL; SAFETY CONTROLLED	0KB05	3351350XX
-6	119-6617-XX			1	FAN ASSEMBLY; DC,12V;0.045A,TACH OUTPUT,4100 RPM,5 CFM,20DBA,40MM X 40MM X 28MM;6 IN,3 LEAD, WITH CONN & HOUSING,SAFETY CONTROLLED	TK6159	1196617XX
-7	211-0208-XX			1	SCREW,MACHINE; 4-40 X 1.625,FLH,100 DEG,STL CD PL,POZ		211-0208-XX
	220-0221-XX			1	NUT ASSY; 4-40 X .250,HEX,LOCK WASHER	78189	501-040800-00
-8	441-2442-XX			1	CHASSIS ASSY; MAIN	0J9P9	4412442XX
-9	211-0734-XX			1	SCREW,MACHINE; 6-32 X 0.250,FLH100,STL,CDPL,T-10 TORX DR	93907	MACHINE SCREW: 6-32 X .250, T1
-10	348-0430-XX			1	BUMPER,PLASTIC; POLYURETHANE,BLACK	2K262	3M-5027
-11	131-6417-XX			1	CONTACT,ELEC; GROUNDING,0.600 L X 0.250 W X 0.220 D,ELECTROLESS NICKEL PLATE	TK6457	131-6417-XX
-12	174-4856-XX			1	CA,ASSY;SP,ELEC,SEMI-RIGID COAX, 0.141 OD	060D9	1744856XX
-13	386-7448-XX			1	PLATE,MOUNTING;AL,SELLWOOD	0J9P9	3867448XX
-14	426-2625-XX			1	MODULAR KIT; RECEPTACLE; PROBE ASSEMBLY, LATCHING, SAFETY CONTROLLED	TK2565	4262625XX
-15	335-0428-XX			1	MARKER,IDENT; LABEL,COSMETIC,RECEPTACLE BOTTOM,BLACK,LEXAN,W/PSA,SAFETY CONTROLLED	0KB05	335-0428-XX
-16	407-5087-XX			1	BRACKET ASSY, TEKCONNECT BUCKET MOUNT	0J9P9	4075087XX
-17	671-6176-XX			1	CIRCUIT BD ASSY;TEKCONNECT INTERFACE CONTROL,W/V1.2 SW APPLICATION	80009	671-6176-XX
Standard Accessories							
	071-1766-XX			1	MANUAL,INSTRUCTION; RTPA2A REAL-TIME SPECTRUM ANALYZER TEKCONNECT PROBE ADAPTER,ENGLISH (standard accessory, if you ordered Option L0)	TK2548	071-1766-XX
	071-1767-XX			1	CARD, QUICK REFERENCE;RTPA2A REAL-TIME SPECTRUM ANALYZER TEKCONNECT PROBE ADAPTER	TK2548	071-1767-XX
	071-1776-XX			1	MANUAL,INSTRUCTION;RTPA2A REAL-TIME SPECTRUM ANALYZER TEKCONNECT PROBE ADAPTER,JAPANESE,PAPER (standard accessory, if you ordered Option L5)	TK2548	071-1776-XX
	174-5218-XX			1	CABLE ASSY;MALE N CONNECTOR TO SMA		174-5218-XX
	103-0058-XX			1	ADAPTER,CONN; N FEMALE TO BNC MALE	24931	29JP119-1
	174-4401-XX			1	CABLE ASSY,I/O; USB, 26 AWG, 3 FT, A TO B, MALE, BLACK	TK6625	CBL-USB2-ABMM3F

Replaceable parts list (Cont.)

Fig. & index number	Tektronix part number	Serial no. effective	Serial no. discontinued	Qty	Name & description	Mfr. code	Mfr. part number
	119-7017-XX			1	POWER SUPPLY; EXTERNAL, DESKTOP (W/SPECIAL MOLEX OUTPUT CONNECTOR) ; 50W, 12VDC 4.1A OUT, 90 - 254VAC 47 - 63 HZ IN; 78% EFF, UL, CSA, PSE, CCC ,SAFETY CONTROLLED	1BSB6	UP05071120MOD
	161-0066-00			1 A0	CABLE ASSY,PWR; 3,18 AWG,250V/10A,98.0 L,STR,IEC320,RCPT X NEMA 5-15P,US,SAFETY CONTROLLED	S3109	161-0066-00
					Optional accessories		
	161-0066-09			1 A1	CABLE ASSY,PWR; 3,0.75MM SQ,250V/10A,99.0 L,STR,IEC320,RCPT,EUROPEAN,SAFETY CONTROLLED	TK6121	2171H518.2
	161-0066-10			1 A2	CABLE ASSY,PWR; 3,1.0 MM SQ,250V/10A,2.5 METER,STR,IEC320,RCPT X 13A,FUSED UK PLUG(13A FUSE),UNITED KINGDOM,SAFETY CONTROLLED	TK6121	21071H518.2
	161-0066-13			1 A3	CABLE ASSY,PWR; 3,1.0 MM SQ,250V/10A,2.5 METER,STR,IEC320,RCPT,AUSTRALIA,SAFETY CONTROLLED	TK1373	161-0066-XX
	161-0104-08			1 A4	CABLE ASSY,PWR; 3,18 AWG,250/10A,98.0 L,RTANG,IEC320,RCPT X STR,NEMA 6-15P,US,SAFETY CONTROLLED	TK6372	161-0104-XX
	161-0154-00			1 A5	CA ASSY,PWR; 3,1.0MM SQ,250V/10A,2.5 METER,STR,IEC320,RCPT,SWISS,SAFETY CONTROLLED	S3109	12-H05VVF3G 00-50
	161-0306-00			1 A10	CABLE ASSY,PWR; 3,1.0MM SQ,250V/10A,2.5 METER,RTANG,IEC320,RCPT,3C CERTIFICATION,CHINA;SAFETY CONTROLLED	TK6253	92-2637-250BKH
	161-A005-00			1 A6	CABLE ASSY,PWR; RT ANGLE, JAPANESE T MARK,SAFETY CONTROLLED	SONY	161-A005-XX

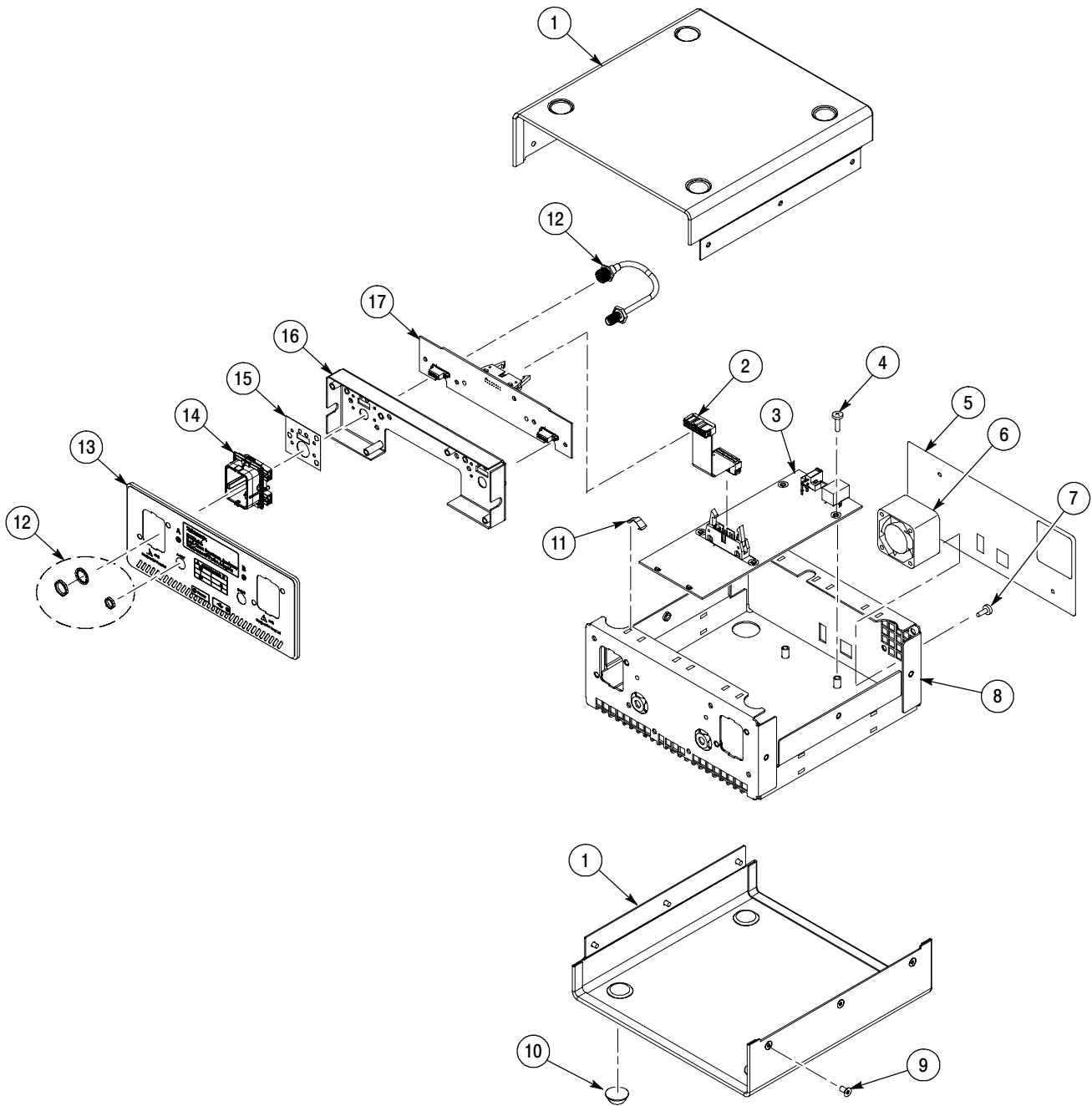

Figure 12: Exploded view